



We, PICOGRAM develop & change our life in the future with environment technology products, which make our life upgraded. PICOGRAM has already completed all preparations to pursue ceaseless innovation to create a new future with boundless dream and challenging spirit. PICOGRAM will realize the vision for the future, doing every effort to form an effective organizational culture by motivating each other to pursue perfection.

picogram

PICOGRAM CO.,LTD.

118, Bupyeongbuk-ro, Bupyeong-gu, Incheon, Korea (2131)

Tel 82-32-678-5114 | Fax 82-32-678-9222

E-mail sales@picogram.co.kr

Update 2021.06 | Made in Korea

www.picogram.com www.purealglobal.com

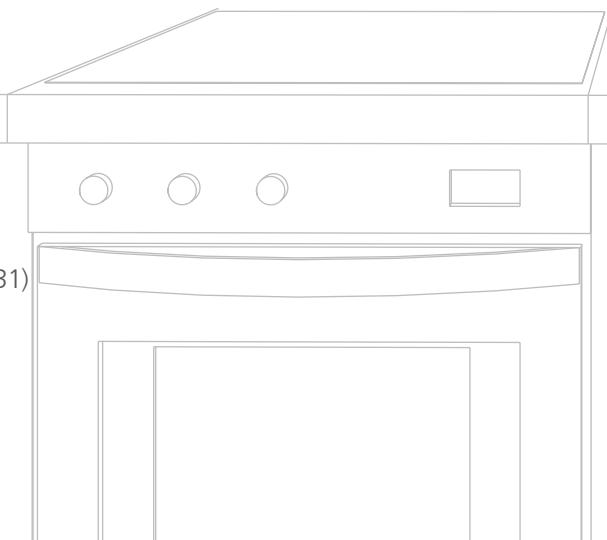



pico*gram*

INVISIBLE WORLD,
PICOGRAM TECHNOLOGY!

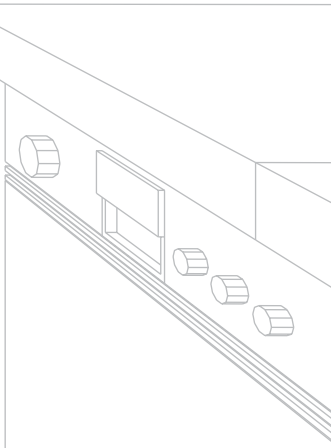

Invisible World, **pico**gram Technology!



Global Network

We have established a global distribution network with the help with many partners and representatives all over the world. We have strong partners in all major markets, which gives us the possibility to react swiftly to your demands worldwide and to provide assistance on site. Our well-organized global distribution network provides us with the necessary local information for markets worldwide. This gives us a valuable insight into these markets. We are looking forward to new challenges of new market, extending our activities and intensifying our business relationships with overseas partners in the future.

Business Area

PICOGRAM is one of the leading manufactures with stable market share, and now we are becoming a leader in the field of filtering technology, by developing new and innovative technology which can satisfy customers. As a leader in the design, manufacture, and marketing of a comprehensive line of filtration products, we has carried on PICOGRAM as a stable, profitable business with long term sustainable development to practice our philosophy and to satisfy our customers by providing added value solutions for water treatment application and serving the convenience of users.

Production Plant

We are continuously improving our internal organization and communications. Our employees are given a chance to submit proposals for improvements and alterations. We have also initiated a company development process which reveals our strengths and weaknesses. In the development and production of our components, we put special emphasis on quality and reliability. We cover a comprehensive range and offer an optimized solution for each application complying with international guidelines. Our technical facilities and production technologies enable us to meet the highest standards in product quality and product performance.

OEM Capability

We are assisting our customers to transition to the latest generation of water treatment solutions, enhancing their relationship with their customers, so that our customers can reduce their operating costs, improve their services. We want to help our customers to increase their productivity and efficiency, improve their capabilities and deliver new services.

Research and Development

We ensure that our products are state of the art in terms of technology and exceed the industrial standard, moving steps forward then others with innovative technologies. PICOGRAM has invested in research and development since it first launched operations and currently has its own research center to increase activities to create new products. These efforts have produced a vast number of water treatment related technologies and have brought about the accumulation of many industrial property rights in and outside of the country. This is why it can become a leader in meeting the needs of its customers and respond to the market accordingly. PICOGRAM has the equipment for experimenting with filter designing and development, alongside having a strong infrastructure for manufacturing high-quality products efficiently. Researchers continue to invest in developing trustworthy products by adopting new technologies and developing key techniques.

PU:ON

LINE CHANGER

PPA-300



Changeable head module

Remove any possibilities of bacteria contamination in water line after filtration.



Quick change filter system by PnP
Premium filter materials
Slim and compact design



Compact & Slim Design



Changeable Head Module



Easy Filter Replacement System



Optimum Filter Solution



No Electricity & No Noise



Changeable Tap & Tray

Product Code	Description	Type	Filter Size	Case Q'ty	Box Dimension (mm)	Weight (kg)
PPA-300	Pureal Line Changer Water Purifier	Push / Turn	8"	2	485x335x404	10



PPA-100



PUREAL has not only slim & compact design, high performance cartridge, sanitary & easy filter replacement, Auto shut-off system and Nano technology as water purifier, but also convenient changeable tray by magnetic. It has also No noise and No electricity.

Special Technology with Slim Design

When the door is open, it shuts off the feed water and release the internal pressure, which will help you replace filters.

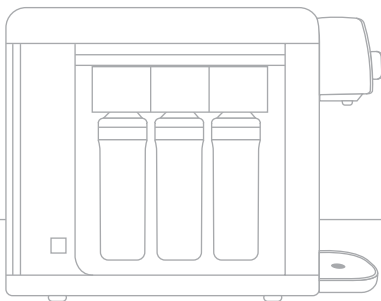

Compact & Slim Design



Exchangeable Tap



Easy Filter Replacement System



Optimum Filter Solution



No Electricity & No Noise



Changeable Tray

Product Code	Description	Type	Filter Size	Case Q'ty	Box Dimension (mm)	Weight (kg)
PPA-100	Pureal Water Purifier	Push / Turn	8"	2	485x335x404	10

PU:ON PREMIUM

PPA-1010



Tankless Water Purifier

Clean & Fresh Water

This system will provide you with fresh water without tank, in which bacterial may grow.

PnP Filter System

Do you still need an engineer?

“Easy One-touch filter replacement”

Pureal water purifier have self-Replacement filter system. So even children can replace filter by themselves.

- No tool and no parts for filter replacement
- One-touch filter replacement system (PnP system)
- Automatic Shut-off water during filter replacement



Compact & Slim Design



Exchangeable Tap



Easy Filter Replacement System



Optimum Filter Solution



No Electricity & No Noise



Changeable Tray

Product Code	Description	Type	Filter Size	Case Q'ty	Box Dimension (mm)	Weight (kg)
PPA-1010	Pureal Premium Water Purifier	Push / Turn	8"	2	485x335x404	10

PU:ON

HYDROGEN

PPH-100



- Stable ORP Performance (Oxidation Reduction Potential max. -400mV)
- Removing Hydroxyl Radical
- Antioxidative Effect
- Healthiest Beverage
- Available to choose Purified Hydrogen Water or Purified Normal Water

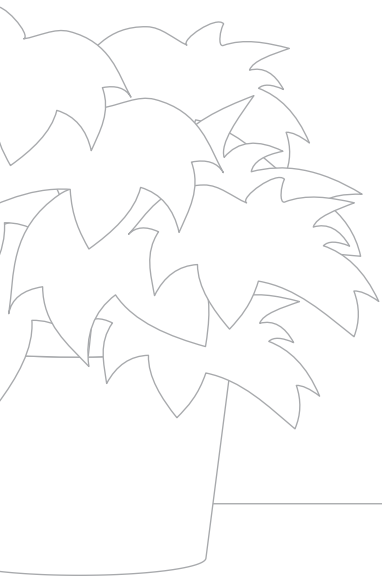

Slim Design



Quick Change



Replaceable Tap



Hydrogen Water



Changeable Tray

Product Code	Description	Type	Filter Size	Case Q'ty	Box Dimension (mm)	Weight (kg)
PPH-100	Pureal Hydrogen Water Purifier	Push / Turn	8"	2	555x335x404	12

PU:ON

HOT

PPA-2111



- Tankless Water Purifier for more clean water
- Detachable Nozzle for Cleaning
- Equipped with Filter Exchange LED Indicator
- Power Saving Available with Instant Water Heating System (Max 85°C)



Slim Design



Quick Change



Replaceable Tap



Hot Water



Changeable Tray

Product Code	Description	Type	Filter Size	Case Q'ty	Box Dimension (mm)	Weight (kg)
PPA-2111	Pureal Hot Water Purifier	Push / Turn	8"	2	555x335x404	12

PU:ON

COLD

PPA-2010



Tankless Cold Water Purifier



Exchangeable Tap



Easy Filter Replacement System



Power Saving System



One-touch Quantitative Extraction



Instant Cooling System









Product Code	Description	Type	Filter Size	Case Q'ty	Box Dimension (mm)	Weight (kg)
PPA-2010	Pureal Cold Water Purifier	Push / Turn	8"	1	635x275x523	15

PU:ON

HOT & COLD

PPA-2110



- 
 Tankless Hot & Cold Water Purifier
- 
 Exchangeable Tap
- 
 Easy Filter Replacement System
- 
 Power Saving System
- 
 One-touch Quantitative Extraction
- 
 Instant Cooling System
- 
 Instant Heating System
- 
 Kids Lock Mode

Product Code	Description	Type	Filter Size	Case Q'ty	Box Dimension (mm)	Weight (kg)
PPA-2110	Pureal Hot & Cold Water Purifier	Push / Turn	8"	1	635x275x523	15

PnP Filter System

PnPTM
plug&play Filter system

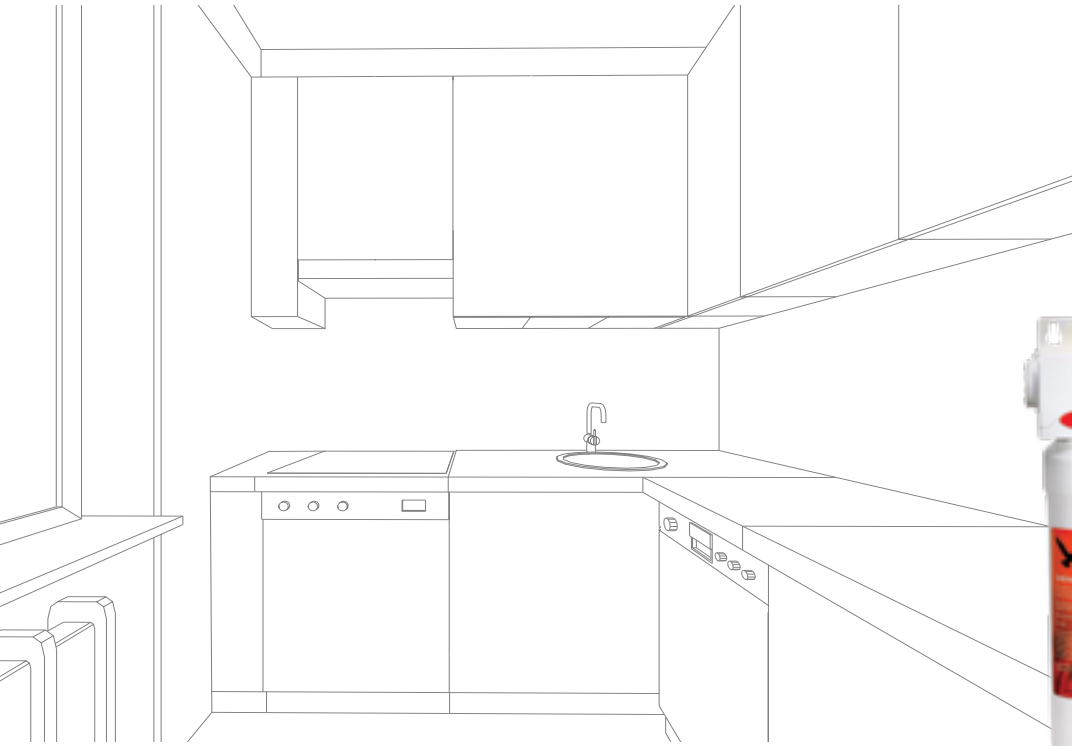

PNP UF SYSTEM

- Minimization of the number of parts
- Automatic shutoff during filter replacement
- Convenient filter replacement
- Strong structure
- Sanitary filter replacement
- Space efficiency
- Securing filter replacement market

What's so complicated?
"No tools & No parts!"



* This model have been applied and patented by international PCT (Patent Cooperation Treaty) at several countries.
So it's strictly prohibited to copy the model without permission.



Complete System

PnP water purification systems provide good clean water at an economical price and give you the highest quality drinking water and the best designed system providing the most complete and compact filtration package. This have a user friendly design that allows its filters and membrane to be changed without using tools, just twist off the old part, twist on the new one or the filters can be changed by simply pushing the buttons. PnP filter system has simplified the connecting of one filter to another, reducing the complication of the standard fitting and tube connection. The greatest strength of this system is that anyone can change the filters without difficulty within a short amount of time. The water cut-off function also frees people from the trouble of having to open and close off the feed water.



PNP EFRO PUMP SYSTEM



PNP RO ASV SYSTEM

*NSF standard compliant materials used

Product Code	Description	Type	Filter Size	Filter Configuration	Case Q'ty	Box Dimension (mm)	Weight (kg)
PNPCUP01	PnP 4 stage UF filter system	Push button type	13"	Sediment+Carbon block+UF +GAC	4	573 X 375 X 290	18
PNPCUP02	PnP 4 stage UF filter system	Push button type	11"	Sediment+Carbon block+UF +GAC	4	573 X 375 X 290	18
PNPCUP03	PnP 4 stage UF filter system	Push button type	10"	Sediment+Carbon block+UF +GAC	4	573 X 375 X 290	17
PNPCUP04	PnP 3 stage UF filter system	Push button type	13"	Sediment+Carbon block+UF	4	573 X 375 X 290	15
PNPCUP05	PnP 3 stage UF filter system	Push button type	11"	Sediment+Carbon block+UF	4	573 X 375 X 290	15
PNPCUP06	PnP 3 stage UF filter system	Push button type	10"	Sediment+Carbon block+UF	4	573 X 375 X 290	14
PNPCOT01	PnP 4 stage UF filter system	Twist type	13"	Sediment+Carbon block+UF +GAC	4	573 X 375 X 290	18
PNPCOT02	PnP 4 stage UF filter system	Twist type	11"	Sediment+Carbon block+UF +GAC	4	573 X 375 X 290	18
PNPCOT03	PnP 4 stage UF filter system	Twist type	10"	Sediment+Carbon block+UF +GAC	4	573 X 375 X 290	16
PNPCOT04	PnP 3 stage UF filter system	Twist type	13"	Sediment+Carbon block+UF	4	573 X 375 X 290	15
PNPCOT05	PnP 3 stage UF filter system	Twist type	11"	Sediment+Carbon block+UF	4	573 X 375 X 290	15
PNPCOT06	PnP 3 stage UF filter system	Twist type	10"	Sediment+Carbon block+UF	4	573 X 375 X 290	14
PNPCUPRO	PnP 4 stage RO filter system (With ASV)	Push type	11"	Sediment+Carbon block+RO-GAC	1	360 X 360 X 400	9
PNPCUTRO	PnP 4 stage RO filter system (With Pump)	Twist type	11"	Sediment+Carbon block+RO-GAC	1	360 X 360 X 400	10
PPR-100	Pureal UTS-EFRO Pump Set(50GPD) (Low Pressure Switch added)	Push/ Turn	11"	Sediment+Carbon block+EFRO-GAC	1	395 X 340 X 390	16
PPR-101	Pureal UTS-EFRO Pump Set(50GPD)	Push/ Turn	11"	Sediment+Carbon block+EFRO-GAC	1	395 X 340 X 390	16



Components for PnP filter system

PnP Head Connector, Push Button Type

The connection structure not only simplified design, by removing trouble with fittings or tubings, its shutoff valves also help save space for installment because they are embedded inside the product using a head connector system.

There are two types of system connections : the push button and the twist type, depending on the PnP connection structure. Once the filter is inserted in the head, water begins to flow, and when the filter is removed for replacement, it in turn, cuts off the water.



Product Code	Description	Type	Filter Size	Filter Configuration	Case Q'ty	Box Dimension (mm)	Weight (kg)
PNPCUP01	PnP Head connector 1 stage	Push button type	1/4" inlet + 1/4" outlet	Filtration	20	470 X 265 X 250	10
PNPCUP02	PnP Head connector 2 stage	Push button type	1/4" inlet + 1/4" outlet	Filtration	10	470 X 265 X 250	7
PNPCUP03	PnP Head connector 3 stage	Push button type	1/4" inlet + 1/4" outlet	Filtration	10	470 X 265 X 250	10
PNPCUP04	PnP Head connector 4 stage	Push button type	1/4" inlet + 1/4" outlet	Filtration	10	470 X 265 X 315	13
PNPCUP05	PnP Head connector 4 stage	Push button type	1/4" inlet + 1/4" Sedi-out + 1/4" Pre-in + 1/4" Brine + 1/4" R.O product + 1/4" outlet	R.O	10	470 X 265 X 315	13



Components for PnP filter system

PnP Head Connector, Twist Type

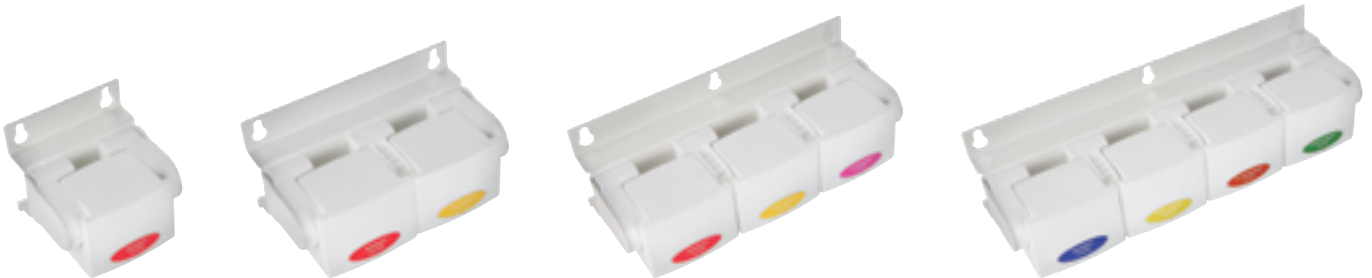
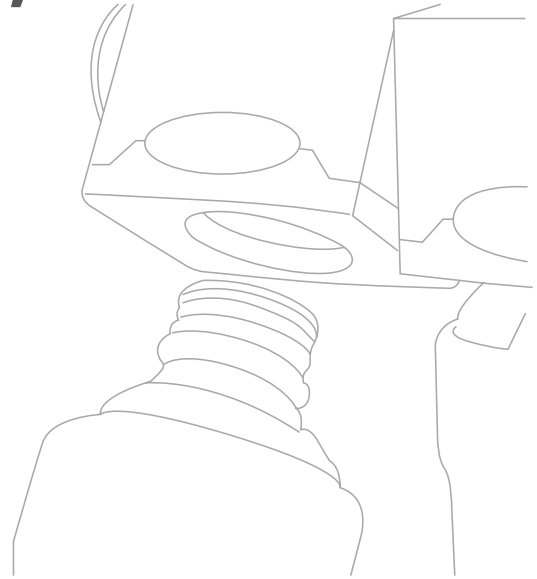

PNPHDT01

PNPHDT02

PNPHDT03

PNPHDT04 / PNPHT05

Product Code	Description	Type	Filter Size	Filter Configuration	Case Q'ty	Box Dimension (mm)	Weight (kg)
PNPHDT01	PnP Head connector 1 stage	Twist type	1/4" inlet + 1/4" outlet	Filtration	20	470 X 265 X 250	10
PNPHDT02	PnP Head connector 2 stage	Twist type	1/4" inlet + 1/4" outlet	Filtration	10	470 X 265 X 250	7
PNPHDT03	PnP Head connector 3 stage	Twist type	1/4" inlet + 1/4" outlet	Filtration	10	470 X 265 X 250	10
PNPHDT04	PnP Head connector 4 stage	Twist type	1/4" inlet + 1/4" outlet	Filtration	10	470 X 265 X 315	13
PNPHDT05	PnP Head connector 4 stage	Twist type	1/4" inlet + 1/4" Sedi-out + 1/4" Pre-in + 1/4" Brine + 1/4" R.O product + 1/4" outlet	R.O	10	470 X 265 X 315	13



Components for PnP filter system

PnP Single Head Connector, Twist Type

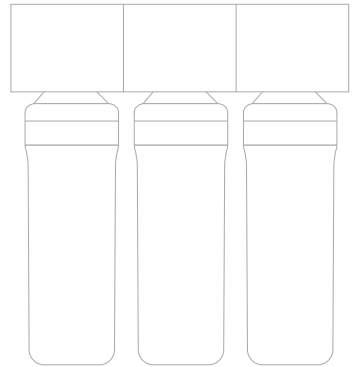

PNPSHDT01



PNPSHDT02



PNPSHDT03



PNPSHDT04 / PNPSHDT05



PNPSHD01



PNPSHD02



PNPSHD03



PNPSHD04

Product Code	Description	Type	Filter Size	Application	Case Q'ty	Box Dimension (mm)	Weight (kg)
PNPSHD01	PnP Single Head Module	Twist type	1/4" inlet + 1/4" outlet	Filtration	120	440 X 364 X 223	8
PNPSHD02	PnP Single Head Module	Twist type	3/8" inlet + 3/8" outlet	Filtration	120	440 X 364 X 223	8
PNPSHD03	PnP Single Head Module	Twist type	1/4" inlet + 1/4" Brine + 1/4" outlet	RO	120	440 X 364 X 223	8
PNPSHD04	PnP Single Head Module	Twist type	3/8" inlet + 1/4" Brine + 3/8" outlet	RO	120	440 X 364 X 223	8
PNPSHDT01	PnP Single Head connector 1 stage	Twist type	1/4" inlet + 1/4" outlet	Filtration	60	335 X 260 X 260	9
PNPSHDT02	PnP Single Head connector 2 stage	Twist type	1/4" inlet + 1/4" outlet	Filtration	10	475 X 265 X 250	6
PNPSHDT03	PnP Single Head connector 3 stage	Twist type	1/4" inlet + 1/4" outlet	Filtration	10	475 X 265 X 250	8
PNPSHDT04	PnP Single Head connector 4 stage	Twist type	1/4" inlet + 1/4" outlet	Filtration	10	475 X 265 X 315	10
PNPSHDT05	PnP Single Head connector 4 stage	Twist type	1/4" inlet + 1/4" Brine + 1/4" R.O product + 1/4" outlet	RO	10	475 X 265 X 315	10



PnP Head Connector, Drawings

Dimension

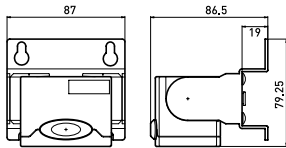

PnP Head connector 1 Stage



PnP Head connector 2 Stage

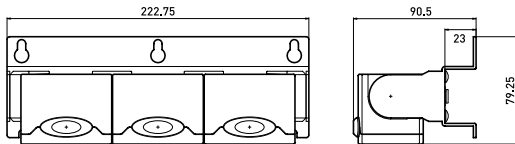

PnP Head connector 3 Stage

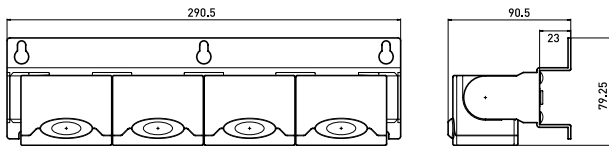

PnP Head connector 4 Stage



PnP Single Head connector 1 Stage

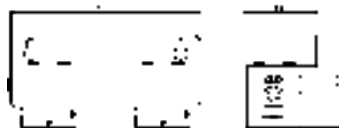

PnP Single Head connector 2 Stage

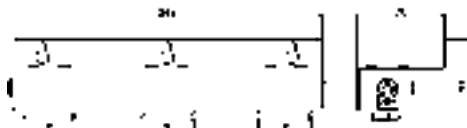

PnP Single Head connector 3 Stage

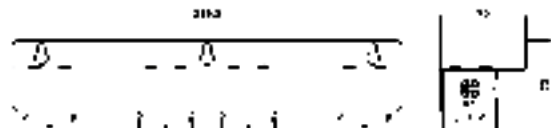

PnP Single Head connector 4 Stage

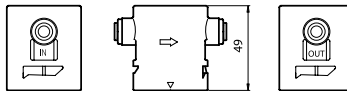
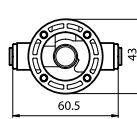

PnP Single Head connector Two ports

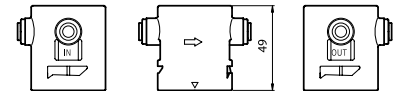
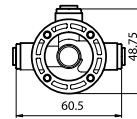

PnP Single Head connector Three ports

Installation_RO

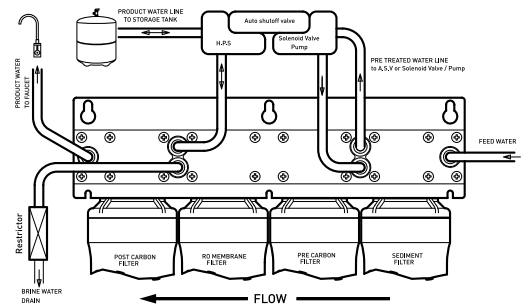

Option A

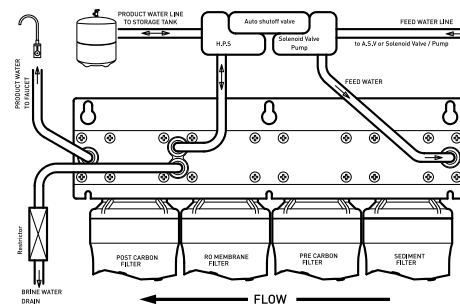

Option B

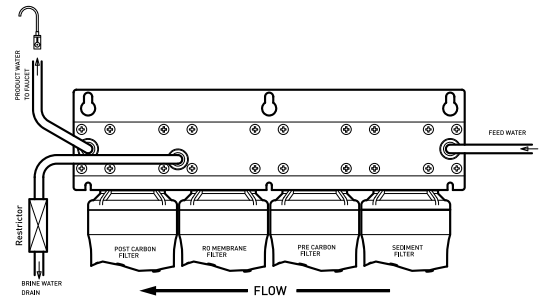



Option C



Components for PnP filter system

PnP Filter



Product Code	Description	Case Q'ty	Box Dimension (mm)	Weight (kg)
Push / Twist				
PNPFTP01 / PNPFTT01	PnP Sediment Filter 8" 5um, PP,Meltblown	25	355 X 355 X 225	5
PNPFTP02 / PNPFTT02	PnP Sediment Filter 10" 5um, PP,Meltblown	35	435 X 315 X 290	7
PNPFTP03 / PNPFTT03	PnP Sediment Filter 11" 5um, PP,Meltblown	25	355 X 355 X 315	8
PNPFTP04 / PNPFTT04	PnP Sediment Filter 13" 5um, PP,Meltblown	25	355 X 355 X 355	9
PNPFTP05 / PNPFTT05	PnP Carbon Block Filter 8"	25	355 X 355 X 225	7
PNPFTP06 / PNPFTT06	PnP Carbon Block Filter 10"	35	435 X 315 X 290	8
PNPFTP07 / PNPFTT07	PnP Carbon Block Filter 11"	25	355 X 355 X 315	10
PNPFTP08 / PNPFTT08	PnP Carbon Block Filter 13"	25	355 X 355 X 355	11
PNPFTP09 / PNPFTT09	PnP Carbon Block Filter 8" • Cyst reduction	25	355 X 355 X 225	7
PNPFTP10 / PNPFTT10	PnP Carbon Block Filter 11" • Cyst reduction	25	355 X 355 X 315	10
PNPFTP11 / PNPFTT11	PnP Carbon Block Filter 13" • Cyst reduction	25	355 X 355 X 355	11
PNPFTP12 / PNPFTT12	PnP Carbon GAC Filter 8"	25	355 X 355 X 225	8
PNPFTP13 / PNPFTT13	PnP Carbon GAC Filter 10"	35	435 X 315 X 290	9
PNPFTP14 / PNPFTT14	PnP Carbon GAC Filter 11"	25	355 X 355 X 315	12
PNPFTP15 / PNPFTT15	PnP Carbon GAC Filter 13"	25	355 X 355 X 355	14
PNPFTP16 / PNPFTT16	PnP Carbon GAC Filter 8" • Scale inhibitor	25	355 X 355 X 225	8
PNPFTP17 / PNPFTT17	PnP Carbon GAC Filter 10" • Scale inhibitor	35	435 X 315 X 290	9
PNPFTP18 / PNPFTT18	PnP Carbon GAC Filter 11" • Scale inhibitor	25	355 X 355 X 315	12
PNPFTP19 / PNPFTT19	PnP Carbon GAC Filter 13" • Scale inhibitor	25	355 X 355 X 355	14
PNPFTP20 / PNPFTT20	PnP Hollow Fiber Filter 8" 0.3um	25	355 X 355 X 225	7
PNPFTP21 / PNPFTT21	PnP Hollow Fiber Filter 10" 0.3um	35	435 X 315 X 290	7
PNPFTP22 / PNPFTT22	PnP Hollow Fiber Filter 11" 0.3um	25	355 X 355 X 315	9
PNPFTP23 / PNPFTT23	PnP Hollow Fiber Filter 13" 0.3um	25	355 X 355 X 355	9
PNPFTP24 / PNPFTT24	PnP R.O Membrane Filter 8" 25GPD	25	355 X 355 X 225	8
PNPFTP25 / PNPFTT25	PnP R.O Membrane Filter 10" 35GPD	35	435 X 315 X 290	9
PNPFTP26 / PNPFTT26	PnP R.O Membrane Filter 11" 50GPD	25	355 X 355 X 315	10
PNPFTP27 / PNPFTT27	PnP R.O Membrane Filter 13" 80GPD	25	355 X 355 X 355	12
PNPFTP28 / PNPFTT28	PnP R.O Membrane Filter 13" 100GPD	25	355 X 355 X 355	13
PNPFTP29 / PNPFTT29	PnP R.O Membrane Filter 13" 150GPD • LP	25	355 X 355 X 355	13
PNPFTT30 / PNPFTT30	PnP EFRO Membrane Filter 11" 50GPD  (Listed No. EFP-ZZXX-YYYY)	25	355 X 355 X 315	10
PNPFTT31 / PNPFTT31	PnP EFRO Membrane Filter 11" 75GPD  (Listed No. EFP-ZZXX-YYYY)	25	355 X 355 X 315	12
PNPFTT32 / PNPFTT32	PnP EFRO Membrane Fiter 13" 100GPD  (Listed No. EFP-ZZXX-YYYY)	25	355 X 355 X 355	13
PNPFTT33 / PNPFTT33	PnP Electro Positive Nano Filter 8"	25	355 X 355 X 225	6
PNPFTT34 / PNPFTT34	PnP Electro Positive Nano Filter 11"	25	355 X 355 X 315	9
PNPFTT35 / PNPFTT35	PnP Electro Positive Nano Filter 13"	25	355 X 355 X 355	10
PNPFTT36 / PNPFTT36	PnP DS (Dual Sediment and Carbon) Filter 8"	25	355 X 355 X 225	7
PNPFTT37 / PNPFTT37	PnP DS (Dual Sediment and Carbon) Filter 11"	25	355 X 355 X 315	10
PNPFTT38 / PNPFTT38	PnP DS (Dual Sediment and Carbon) Filter 13"	25	355 X 355 X 355	11
PNPFTT39 / PNPFTT39	PnP Alkaline Filter 11"	25	355 X 355 X 315	18
PNPFTT40 / PNPFTT40	PnP Alkaline Filter 13"	25	355 X 355 X 355	21



Components for PnP filter system

PnP Filter Specification



While other filters can easily be damaged because of the protruding nipples, the PnP system has a strong structure which reduces those risks when being moved around. The inside material of the filters are also encapsulated, making it cleaner and safer to use by preventing direct contact with various pollutants.

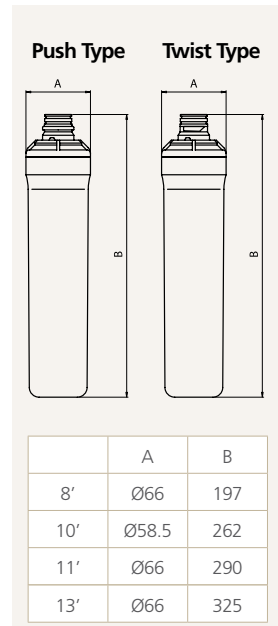

Items		Sediment	Carbon Block	Carbon GAC	UF	RO	Nano	
Materials	Vessel	PP	PP	PP	PP	PP	PP	
	Media	PP	PAC	GAC 20×40mesh	Polysulfone	Polysulfone	PP	
Minimum Production Rate (gallon per day / GPD)		N/A	N/A	N/A	N/A	35, 50, 60, 80, 100, 120, 150GPD	N/A	
Recovery Rate (% of total input flow)		100%	100%	100%	100%	15 • 25%	100%	
Minimum Flow Rate at 15 psig-dynamic		0.5 gallon/min.						0.5 gallon/min
Operating Temperature (°F)		40-100°F (4-38°C)						40-100°F (4-38°C)
Pore size(μm)		Nominal 5μm	Nominal 2.5μm	N/A	Nominal 0.1μm	0.0001μm	Nominal 0.1μm	
	8 inch	41.5×20×127mm	41.5×22×127mm	210cc / 105g	105mm / 0.35m ³		45*15*115	
	10 inch	41.5×20×193mm	41.5×22×193mm	245cc / 115g	105mm / 0.35m ³		-	
	11 inch	41.5×20×215mm	41.5×22×215mm	340cc / 165g	130mm / 0.46m ³		45*15*115	
	13 inch	41.5×20×251mm	41.5×22×251mm	405cc / 195g	130mm / 0.46m ³		45*15*115	
Working pressure		10 • 125 psi			10 • 60 psi	35 • 125 psi	10 • 60 psi	



puri™ series

It brings you Premium quality of drinking water with the most complete and compact filtration package. This specially designed filtration package and Picogram's unique filter blend provide a consistently better-tasting supply of water and user friendly and exceptional design makes added-value solution available to your drinking water system. You can truly enjoy the purity and convenience.

Streamline

- Unique design by harmonization of curve and line
- Polished finish
- User friendly
- Proprietary Cartridges

Pure

- Excellent filtration performance
- The most complete and compact filtration
- Unique filter blend, providing healthy, better tasting water

Comfortable

- Easy installation
- Sanitary Quick Change filter cartridge
- Convenient filter replacement by twisting on and off

Reliable

- Proven Robust structure by PnP technology
- Cartridges with double O-rings. No leaks!
- Greater reliability with fewer tube connection
- Most components can be integrated on the back bracket.

Flexible

- Applicable to other water treatment unit as component
- Extended to various stage filtration



*This model have been applied and patented by international PCT (Patent Cooperation Treaty) at several countries. So it's strictly prohibited to copy the model without permission.



Components for Puri-series

Puri-series Filters & Head Connector



The newly designed Puri-5 filter system is user friendly with design simplicity. It is easy to install & maintain thanks to simple connection of the filter to another with no tools & no spills. This compact design allows maximum use of space under the sink. Picogram's unique filter blend using activated carbon reduces chlorine taste and odor and other offensive contaminant. Proven combination of the most effective water treatment technologies known provides superior quality drinking water at less cost than bottled water.

Puri-series Filters

Product Code	Description	Case Q'ty	Box Dimension (mm)	Weight (kg)	Remarks
PURIFTO1	Puri Sediment Filter 8" Sum, PP,Meltblown	25	355 X 355 X 225	5	
PURIFTO2	Puri Sediment Filter 11" 5um, PP, Meltblown	25	355 X 355 X 315	8	
PURIFTO3	Puri Sediment Filter 13" 5um, PP, Meltblown	25	355 X 355 X 355	9	
PURIFTO4	Puri Carbon Block Filter 8"	25	355 X 355 X 225	7	
PURIFTO5	Puri Carbon Block Filter 11"	25	355 X 355 X 315	9	
PURIFTO6	Puri Carbon Block Filter 13"	25	355 X 355 X 355	11	
PURIFTO7	Puri Carbon GAC Filter 8"	25	355 X 355 X 225	7	
PURIFTO8	Puri Carbon GAC Filter 11"	25	355 X 355 X 315	14	
PURIFTO9	Puri Carbon GAC Filter 13"	25	355 X 355 X 355	11	
PURIFTO10	Puri Hollow Fiber Filter 8" 0.3um	25	355 X 355 X 225	7	
PURIFTO11	Puri Hollow Fiber Filter 11" 0.3um	25	355 X 355 X 315	10	
PURIFTO12	Puri Hollow Fiber Filter 13" 0.3um	25	355 X 355 X 355	9	
PURIFTO13	Puri R.O Membrane Filter 8" 25GPD	25	355 X 355 X 225	8	
PURIFTO14	Puri R.O Membrane Filter 11" 25GPD	25	355 X 355 X 315	10	
PURIFTO15	Puri R.O Membrane Filter 13" 50 / 75 / 100GPD	25	355 X 355 X 355	12	

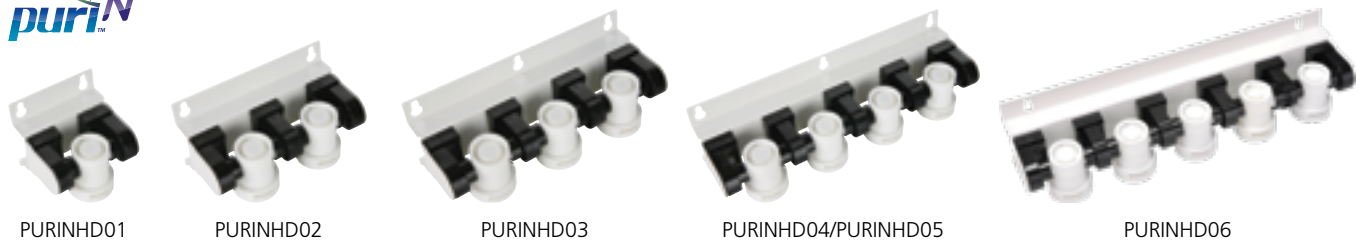

PURINH01

PURINH02

PURINH03

PURINH04/PURINH05

PURINH06

Puri-N Head Connector With Casing

Product Code	Description	Ports	Remarks	Case Q'ty	Box Dimension (mm)	Weight (kg)
PURINH01	Puri-N Head connector 1 stage	1/4" inlet + 1/4" outlet	without casing, Filtration	20	475 X 265 X 250	10
PURINH02	Puri-N Head connector 2 stage	1/4" inlet + 1/4" outlet	without casing, Filtration	10	475 X 265 X 250	7
PURINH03	Puri-N Head connector 3 stage	1/4" inlet + 1/4" outlet	without casing, Filtration	10	475 X 265 X 250	9
PURINH04	Puri-N Head connector 4 stage	1/4" inlet + 1/4" outlet	without casing, Filtration	10	475 X 265 X 315	11
PURINH05	Puri-N Head connector 4 stage	1/4" inlet + 1/4" Sedi-out + 1/4" Pre-in + 1/4" Brine + 1/4" R.O product + 1/4" outlet	without casing, R.O product	10	475 X 265 X 315	11
PURINH06	Puri-N Head connector 5 stage	1/4" inlet + 1/4" Sedi-out + 1/4" Pre-in + 1/4" Brine + 1/4" R.O product + 1/4" outlet	without casing, R.O product	10	620 X 395 X 210	11



Components for Puri-series

Puri-series Head Connector



PURI5HD01



PURI5HD02



PURI5HD03



PURI5HD04 / PURI5HD05



PURI5HD06

Puri-5 Head Connector With Casing

Product Code	Description	Ports	Remarks	Case Q'ty	Box Dimension (mm)	Weight (kg)
PURI5HD01	Puri-5 Head connector 1 stage	1/4" inlet + 1/4" outlet	with casing, Filtration	20	475 X 265 X 250	12
PURI5HD02	Puri-5 Head connector 2 stage	1/4" inlet + 1/4" outlet	with casing, Filtration	10	475 X 265 X 250	8
PURI5HD03	Puri-5 Head connector 3 stage	1/4" inlet + 1/4" outlet	with casing, Filtration	10	475 X 265 X 250	10
PURI5HD04	Puri-5 Head connector 4 stage	1/4" inlet + 1/4" outlet	with casing, Filtration	10	475 X 265 X 315	12
PURI5HD05	Puri-5 Head connector 4 stage	1/4" inlet + 1/4" Sedi-out + 1/4" Pre-in + 1/4" Brine + 1/4" R.O product + 1/4" outlet	with new casing, R.O system	10	475 X 265 X 315	12
PURI5HD06	Puri-5 Head connector 5 stage	1/4" inlet + 1/4" Sedi-out + 1/4" Pre-in + 1/4" Brine + 1/4" R.O product + 1/4" outlet	with new casing, R.O system	10	620 X 395 X 210	14



PURI7HD01



PURI7HD02



PURI7HD03



PURI7HD04 / PURI7HD05



PURI7HD06

Puri-7 Head Connector With Casing

Product Code	Description	Ports	Remarks	Case Q'ty	Box Dimension (mm)	Weight (kg)
PURI7HD01	Puri-7 Head connector 1 stage	1/4" inlet + 1/4" outlet	with casing, Filtration	20	475 X 265 X 250	12
PURI7HD02	Puri-7 Head connector 2 stage	1/4" inlet + 1/4" outlet	with casing, Filtration	10	475 X 265 X 250	8
PURI7HD03	Puri-7 Head connector 3 stage	1/4" inlet + 1/4" outlet	with casing, Filtration	10	475 X 265 X 250	10
PURI7HD04	Puri-7 Head connector 4 stage	1/4" inlet + 1/4" outlet	with casing, Filtration	10	475 X 265 X 315	12
PURI7HD05	Puri-7 Head connector 4 stage	1/4" inlet + 1/4" Sedi-out + 1/4" Pre-in + 1/4" Brine + 1/4" R.O product + 1/4" outlet	with new casing, R.O system	10	475 X 265 X 315	12
PURI7HD06	Puri-7 Head connector 5 stage	1/4" inlet + 1/4" Sedi-out + 1/4" Pre-in + 1/4" Brine + 1/4" R.O product + 1/4" outlet	with new casing, R.O system	10	620 X 395 X 210	14



Components for Puri

Puri Head Connector, Drawings

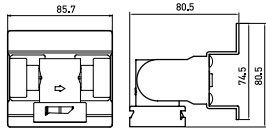

Puri-5 Head connector 1 stage (without casing)

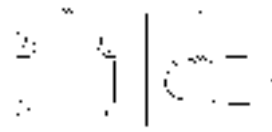

Puri-5 Head connector 1 stage (with casing)

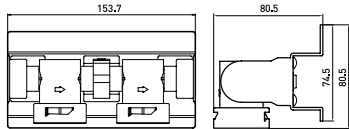

Puri-5 Head connector 2 stage (without casing)

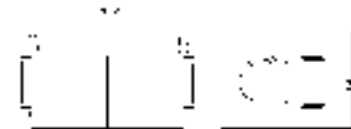

Puri-5 Head connector 2 stage (with casing)

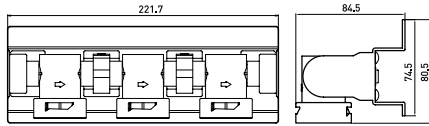

Puri-5 Head connector 3 stage (without casing)

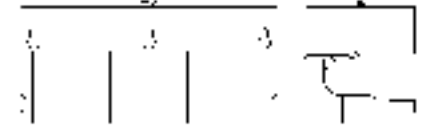

Puri-5 Head connector 3 stage (with casing)

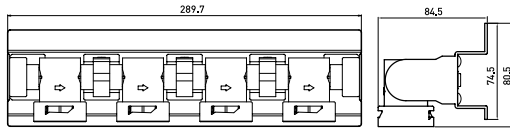

Puri-5 Head connector 4 stage (without casing)

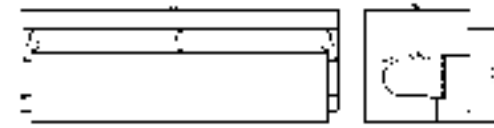

Puri-5 Head connector 4 stage (with casing)



Puri-5 Head connector 5 stage (without casing)

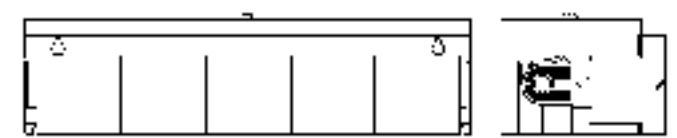

Puri-5 Head connector 5 stage (with casing)

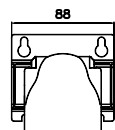

Puri-5 Head connector 1 stage (with new casing)

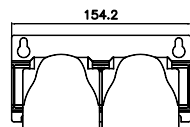
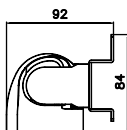

Puri-5 Head connector 2 stage (with new casing)

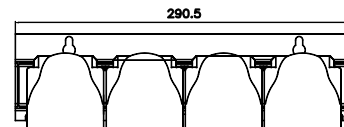
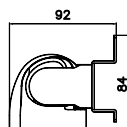

Puri-5 Head connector 4 stage (with new casing)

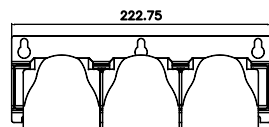
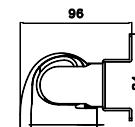

Puri-5 Head connector 3 stage (with new casing)

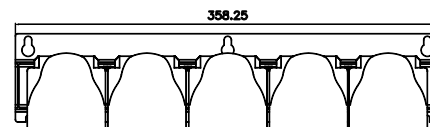
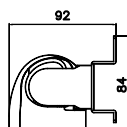

Puri-5 Head connector 5 stage (with new casing)

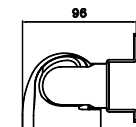

ECO-series

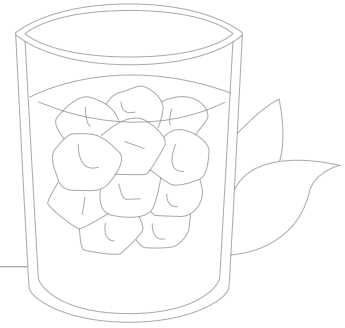

The Eco-Series provides cleaner, better tasting water through the most advanced filtering technology with the exceptional performance of our unique cartridge design. This product offers various stage filtration, incorporating separate sediment and chlorine taste & odor filters and carbon block post-filter for superior flow with configuration flexibility. Our most affordable filtration system helps safeguard you and your family against harmful contaminants such as lead, cysts and asbestos and the sanitary quick-change cartridge design makes cartridge replacement easy.



Benefit

- Small compact design fits easily under your sink
- Reduces Chlorine Taste and Odor
- Easy-change replacement filter by twist system
- Flexible Configuration (UF)

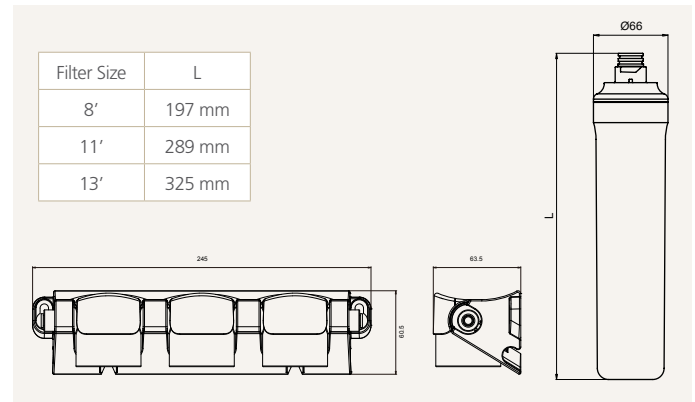

Product Code	Description	Case Q'ty	Box Dimension (mm)	Weight (kg)
ECOHTD01	ECO Head connector 3 stage	10	475 X 265 X 250	7
ECOFTT01	ECO Sediment filter 11" (Twist Type)	25	355 X 355 X 315	8
ECOFTT02	ECO Carbon block filter 11" (Twist Type)	25	355 X 355 X 315	10
ECOFTT03	ECO Carbon GAC filter 11" (Twist Type)	25	355 X 355 X 315	12
ECOFTT04	ECO R.O Membrane filter 11" 50GPD (Twist Type)	25	355 X 355 X 315	10
ECOFTT05	ECO Hollow Fiber filter 11" (Twist Type)	25	355 X 355 X 315	9

Inline Filters

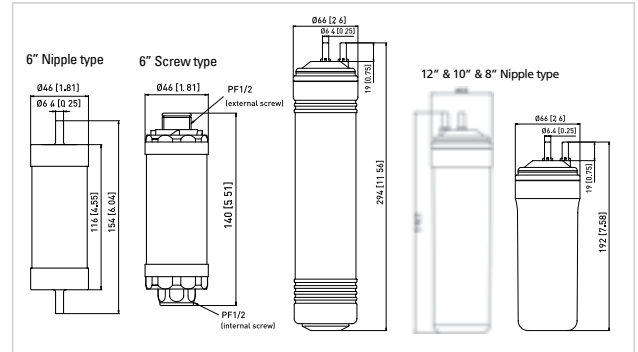

Product Code	Description	Case Q'ty	Box Dimension (mm)	Weight (kg)
INFT01	Inline Sediment Filter 12" 5um, PP,Meltblown , 1/4" nipple	25	355 X 355 X 355	9
INFT02	Inline Carbon Block Filter 12", 1/4" nipple	25	355 X 355 X 355	10
INFT03	Inline Carbon GAC Filter 12" , 1/4" nipple	25	355 X 355 X 355	13
INFT04	Inline Hollow Fiber Filter 12" 0.3um , 1/4" nipple	25	355 X 355 X 355	9
INFT05	Inline R.O Membrane Filter 12" 50GPD , 1/4" nipple	25	355 X 355 X 355	12
INFT06	Inline Nano Alumina Filter 12" nipple	25	355 X 355 X 355	9
INFT07	Inline Sediment Filter 10" 5um, PP,Meltblown , 1/4" nipple	25	355 X 355 X 255	5
INFT08	Inline Carbon Block Filter 10", 1/4" nipple	25	355 X 355 X 255	7
INFT09	Inline Carbon GAC Filter 10" , 1/4" nipple	25	355 X 355 X 255	8
INFT10	Inline Hollow Fiber Filter 10" 0.3um , 1/4" nipple	25	355 X 355 X 255	7
INFT11	Inline R.O Membrane Filter 10" 25GPD , 1/4" nipple	25	355 X 355 X 255	7
INFT12	Inline Nano Alumina Filter 10" nipple	25	355 X 355 X 255	7
INFT13	Inline Sediment Filter 8" 5um, PP,Meltblown , 1/4" nipple	25	355 X 355 X 255	7
INFT14	Inline Carbon Block Filter 8", 1/4" nipple	25	355 X 355 X 255	8
INFT15	Inline Carbon GAC Filter 8", 1/4" nipple	25	355 X 355 X 255	9
INFT16	Inline Hollow Fiber Filter 8" 0.3um , 1/4" nipple	25	355 X 355 X 255	7
INFT17	Inline Sediment Filter 6" 5um, PP,Meltblown , 1/4" nipple	100	650 X 330 X 265	10
INFT18	Inline Carbon GAC Filter 6" , 1/4" nipple	100	650 X 330 X 265	12
INFT19	Inline Hollow Fiber Filter 6" 0.3um , 1/4" nipple	100	650 X 330 X 265	10
INFT20	Inline Vitamin C Filter 6" 1/4" nipple	100	650 X 330 X 265	14
INFT21	Inline Sediment Filter 6" 5um, PP,Meltblown , 1/2" Screw	100	470 X 285 X 260	10
INFT22	Inline Carbon GAC Filter 6" , 1/2" Screw	100	470 X 285 X 260	12
INFT23	Inline Hollow Fiber Filter 6" 0.3um , 1/2" Screw	100	470 X 285 X 260	10
INFT24	Inline Vitamin C Filter 6" 1/2" Screw	100	470 X 285 X 260	14
INFT25	Inline Electro Positive Nano Filter 6" 1/2" Screw	100	470 X 285 X 260	10

Maxtream

Commercial Water Treatment Solution

The presence of unpleasant or excessive concentrations of dissolved minerals in many water supplies effect a food service operation in several ways. Food and beverages taste or appear different. Equipment scales-up and does not function correctly, or over time fails to function at all. Our commercial filters provide high quality water for coffee brewing and drinking water at a reasonable price. Cartridge changes are quick and easy. In many restaurants or coffee shops, operations are seeking ways to supplement or replace their bottled water service that all too often results in significant waste. Picogram has developed our premium food system in respond to this demand. Our food system gives the best solution for the operations and the environment by offering premium water.



Convenient

- Fast & Easy filter replacement by SQC(Sanitary Quick Change)
- Simple installation
- No electricity & Tank requirement

Flexible

- Easy installation with various connection
- 3/8" thread type, 3/8" fitting type
- Series or parallel connection available between RO cartridges
- Various configuration according to installation condition
- Easy expandability
- Easy to install valves,Instruments

Sanitary & Reliable

- Sanitary in design with no contact with the media during cartridge change-out
- No Secondary contamination
- Structure assurance (Satisfaction with NSF Structure test requirement)
- Leakage protection by Dual O-ring.
- NSF standard compliant materials

Applicable

- Multiple application through rich product water at the same time.
- Applicable to drinking water, coffer machine, ice-making, steam heater.



Feature & Application

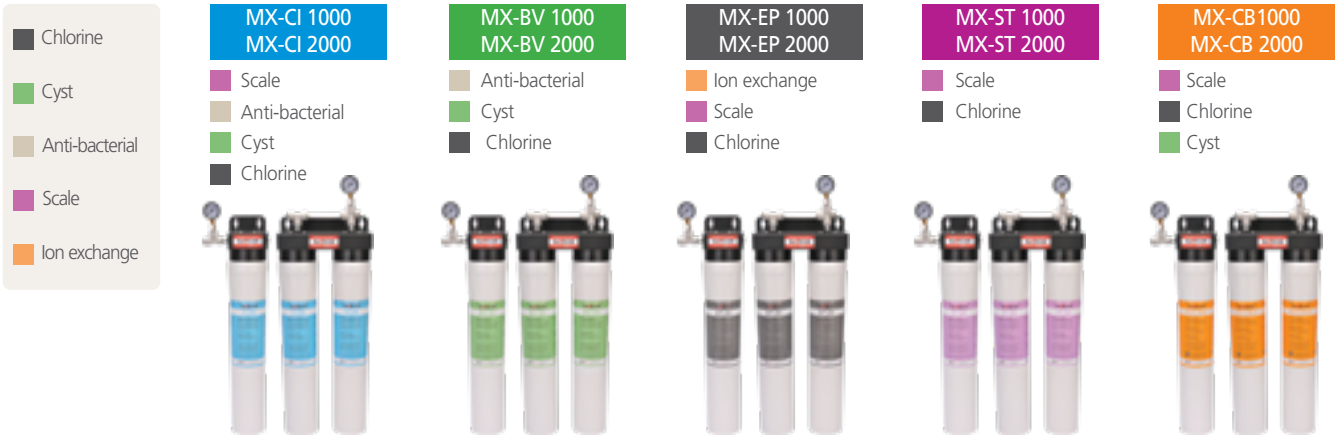

- Chlorine
- Cyst
- Anti-bacterial
- Scale
- Ion exchange

MX-CI 1000
MX-CI 2000

MX-BV 1000
MX-BV 2000

MX-EP 1000
MX-EP 2000

MX-ST 1000
MX-ST 2000

MX-CB 1000
MX-CB 2000

- Scale
- Anti-bacterial
- Cyst
- Chlorine

- Anti-bacterial
- Cyst
- Chlorine

- Ion exchange
- Scale
- Chlorine

- Scale
- Chlorine

- Scale
- Chlorine
- Cyst

ICE MAKER
COFFEE

COLD BEVERAGE

ESPRESSO

STEAMER

COOKING
DRINKING

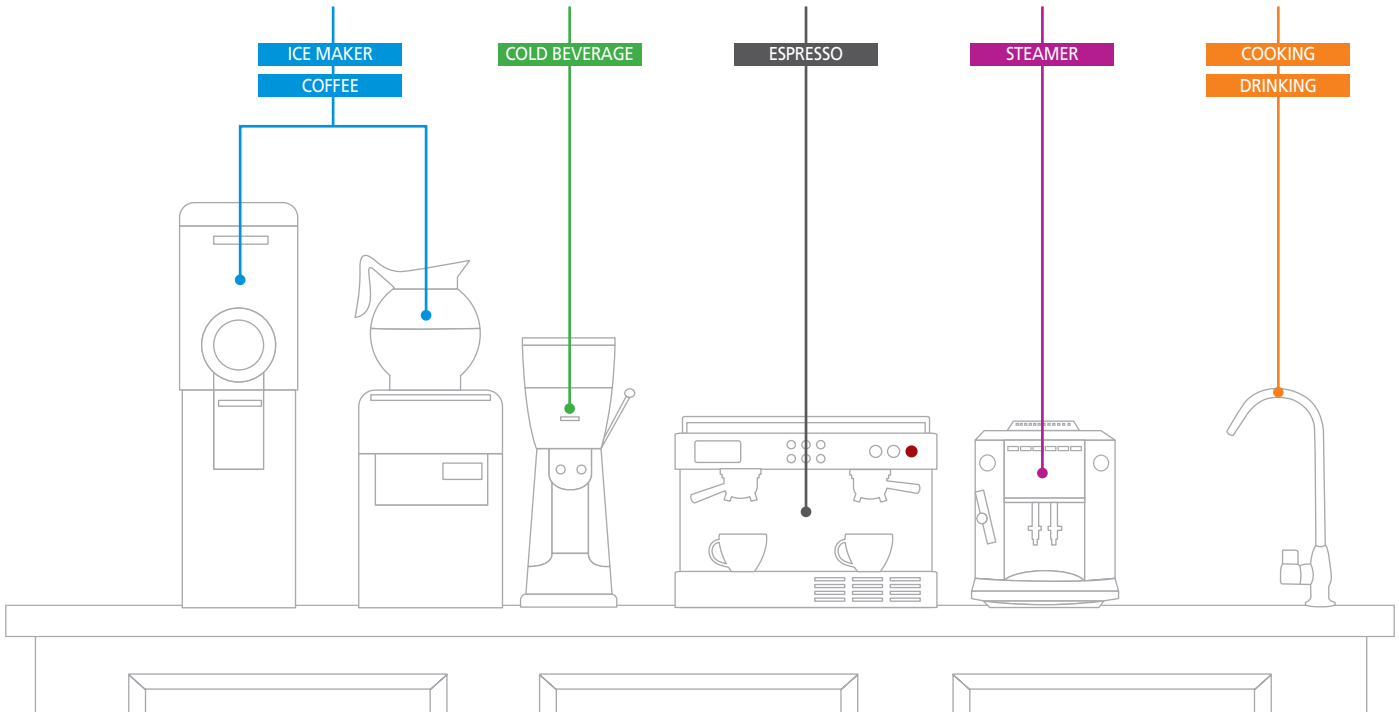

Model	Chlorine	Cyst	Anti-bacterial	Scale	Flow Rate	Capacity	Replacement Cartridge	Remarks
MX-EP 2000	●			●	11.34LPM	30,000L	EP20	Espresso Softening resin
MX-CI 2000	●	●	●	●	15.2LPM	170,000L	CI20	Coffee & Ice cube VOCs Reduction
MX-ST 2000	●			●	15.2LPM	90,000L	ST20	Steamer
MX-BV 2000	●	●	●		15.2LPM	170,000L	BV20	Cold beverage VOCs Reduction
MX-CB 2000	●	●		●	15.2LPM	113,550L	CB20	Cooking & Drinking Water



Components for MAXTREAM

Maxtream Filters & Set



MXEP1000
MXEP2000

MXST1000
MXST2000

MXBV1000
MXBV2000

MXCI1000
MXCI2000

MXCB1000
MXCB2000

MAXTREAM Commercial Filters

Product Code	Description	Case Q'ty	Box Dimension (mm)	Weight (kg)
MXCB15	MAXTREAM 15" CB-15 Carbon Block Filter (Scale inhibitor)	6	385 X 265 X 400	8
MXCB20	MAXTREAM 20" CB-20 Carbon Block Filter (Scale inhibitor)	6	385 X 265 X 530	11
MXEP20	MAXTREAM 20" EP-20 Filter (Sediment + Carbon + Ion exchange resin + Scale inhibitor)	6	385 X 265 X 530	12
MXST20	MAXTREAM 20" ST-20 Filter (Double Sediment + Carbon + Scale inhibitor)	6	385 X 265 X 530	10
MXBV20	MAXTREAM 20" BV-20 Filter (Cyst reduction Carbon + Anti-bacterial ceramic)	6	385 X 265 X 530	11
MXCI20	MAXTREAM 20" CI-20 Filter (Cyst reduction Carbon + Anti-bacterial ceramic + Scale inhibitor)	6	385 X 265 X 530	11
MXCC15	MAXTREAM 15" CC-15 Filter (Cyst reduction)  Listed No. PPC6T1F15XXZ	6	385 X 265 X 400	8

MAXTREAM Commercial Set

Product Code	Description	Case Q'ty	Box Dimension (mm)	Weight (kg)
MXCB1000	MAXTREAM 1 stage 20" MX-CB 1000 Carbon Block Filter (Scale inhibitor)	1	685 X 285 X 290	11
MXEP1000	MAXTREAM 1 stage 20" MX-EP 1000 Filter (Sediment + Carbon + Ion exchange resin + Scale inhibitor)	1	686 X 285 X 290	10
MXST1000	MAXTREAM 1 stage 20" MX-ST 1000 Filter (Double Sediment + Carbon + Scale inhibitor)	1	687 X 285 X 290	10
MXBV1000	MAXTREAM 1 stage 20" MX-BV 1000 Filter (Cyst reduction Carbon + Anti-bacterial ceramic)	1	688 X 285 X 290	11
MXCI1000	MAXTREAM 1 stage 20" MX-CI 1000 Filter (Cyst reduction Carbon + Anti-bacterial ceramic + Scale inhibitor)	1	689 X 285 X 290	11
MXCB2000	MAXTREAM 2 stage 20" MX-CB 2000 Carbon Block Filter (Scale inhibitor) • Parallel connection	1	690 X 265 X 295	10
MXEP2000	MAXTREAM 2 stage 20" MX-EP 2000 Filter (Sediment + Carbon + Ion exchange resin + Scale inhibitor) • Parallel connection	1	691 X 265 X 295	9
MXST2000	MAXTREAM 2 stage 20" MX-ST 2000 Filter (Double Sediment + Carbon + Scale inhibitor) • Parallel connection	1	692 X 265 X 295	9
MXBV2000	MAXTREAM 2 stage 20" MX-BV 2000 Filter (Cyst reduction Carbon + Anti-bacterial ceramic) • Parallel connection	1	693 X 265 X 295	10
MXCI2000	MAXTREAM 2 stage 20" MX-CI 2000 Filter (Cyst reduction Carbon + Anti-bacterial ceramic + Scale inhibitor) • Parallel connection	1	694 X 265 X 295	10



Components for MAXTREAM

Maxtream Head Connector



MXHD01



MXHD02



MXHD03



MXSHD01



MXSHD02



MXSHD03



MXSHD04



MXSHD05



MXSHD06



MXSHD07

The presence of unpleasant or excessive concentrations of dissolved minerals in many water supplies effect a food service operation in several ways. Food and beverages taste or appear different. Equipment scales-up and does not function correctly, or over time fails to function at all. Our commercial filters provide high quality water for coffee brewing and drinking water at a reasonable price. With an automatic water shut off feature built into the filter head, cartridge changes are quick and easy.

Product Code	Description	Ports	Application	Case Q'ty	Box Dimension (mm)	Weight (kg)
MXHD01	MAXTREAM PnP-CM 1 stage head connector	3/8" inlet quick side + 3/8" outlet quick side	Filtration	27	485 X 280 X 222	14
MXHD02	MAXTREAM PnP-CM 2 stage head connector	3/8" inlet quick on top + 3/8" outlet quick on top	Filtration	5	485 X 280 X 250	6
MXHD02	MAXTREAM PnP-CM 3 stage head connector	3/8" inlet quick on top + 3/8" outlet quick on top + 3/8" brine quick on top	R.O	5	485 X 280 X 250	9
MXHD01	MAXTREAM Single Commercial head	3/8" inlet quick on top + 3/8" outlet quick on top	Filtration	48	394 X 300 X 295	11
MXHD02	MAXTREAM Single Commercial head	3/8" inlet quick side + 3/8" outlet quick side	Filtration	48	395 X 300 X 295	11
MXHD03	MAXTREAM Single Commercial head	3/8" inlet screw side+ 3/8" outlet screw side	Filtration	48	396 X 300 X 295	11
MXHD04	MAXTREAM Single Commercial head	3/8" inlet quick on top + 3/8" outlet quick on top + 3/8" brine quick on top	R.O	48	397 X 300 X 295	11
MXHD05	MAXTREAM Single Commercial head	3/8" inlet quick side + 3/8" outlet quick side + 3/8" brine quick on top	R.O	48	398 X 300 X 295	11
MXHD06	MAXTREAM Single Commercial head	3/8" inlet screw side+ 3/8" outlet screw side + 3/8" brine quick on top	R.O	48	399 X 300 X 295	11
MXHD07	MAXTREAM Single Commercial head with casing	3/8" inlet quick side+ 3/8" outlet quick side	Filtration	27	370 X 337 X 355	8

Components for MAXTREAM

Commercial Head Connector, Dimension

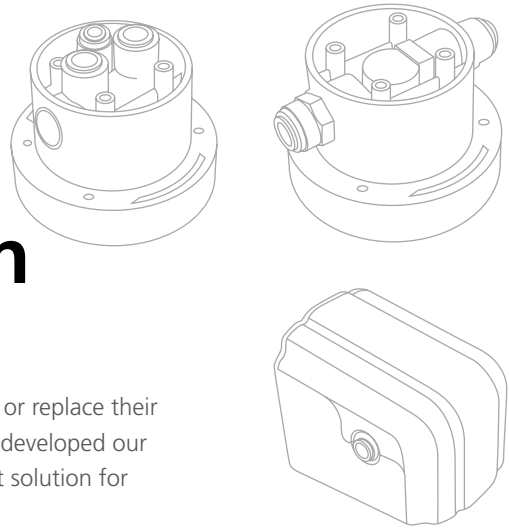

In many restaurants or coffee shops, operations are seeking ways to supplement or replace their bottled water service that all too often results in significant waste. Picogram has developed our premium food system in respond to this demand. Our food system gives the best solution for the operations and the environment by offering premium water.

	Option1	Option2	Option3
Filtration	<p>PNPMSHD3</p>	<p>PNPMSHD2</p>	<p>PNPMSHD1</p>
R/O	<p>PNPMSHD6</p>	<p>PNPMSHD5</p>	<p>PNPMSHD4</p>

Drawing

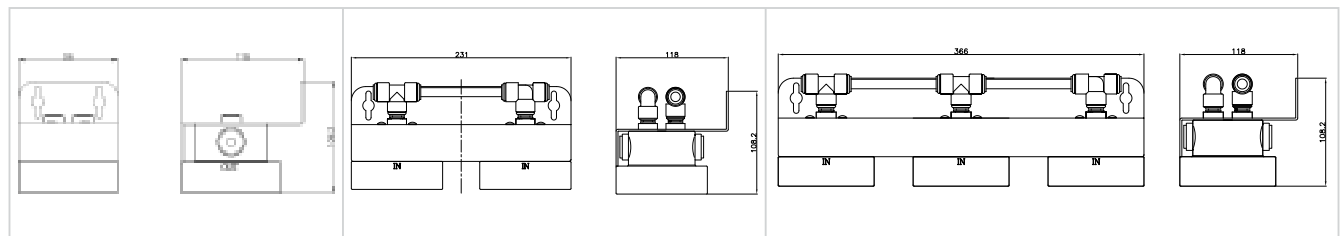



Components for MAXTREAM Commercial Filters



H1

Filter Size	H1
20"	Ø3.93" X 20"
	(Ø100 X 508)mm
15"	Ø3.93" X 15"
	(Ø100 X 381)mm

Product Code	Description	Case Q'ty	Box Dimension (mm)	Weight (kg)
MXFT01	MAXTREAM Commercial Filter 20" Carbon filter (GAC)	6	385 X 265 X 530	12
MXFT02	MAXTREAM Commercial Filter 20" Carbon filter (GAC) (Scale inhibitor)	6	385 X 265 X 530	12
MXFT03	MAXTREAM Commercial Filter 20" Carbon Block Filter	6	385 X 265 X 530	11
MXFT04	MAXTREAM Commercial Filter 20" Carbon Block Filter (Lead reduction)	6	385 X 265 X 530	11
MXFT05	MAXTREAM Commercial Filter 20" Carbon Block Filter (Scale inhibitor)	6	385 X 265 X 530	11
MXFT06	MAXTREAM Commercial Filter 20" Carbon Block Filter (Lead reduction & Scale reduction)	6	385 X 265 X 530	11
MXFT07	MAXTREAM Commercial Filter 20" Carbon Block Filter (Cyst reduction)	6	385 X 265 X 530	11
MXFT08	MAXTREAM Commercial Filter 20" Carbon Block Filter (Lead reduction & Cyst reduction)	6	385 X 265 X 530	11
MXFT09	MAXTREAM Commercial Filter 20" Carbon Block Filter (Scale inhibitor & Cyst reduction)	6	385 X 265 X 530	11
MXFT10	MAXTREAM Commercial Filter 20" Carbon Block Filter (Lead reduction & Scale reduction & Cyst reduction)	6	385 X 265 X 530	11
MXFT11	MAXTREAM Commercial Filter 20" UF + Carbon Block Filter	6	385 X 265 X 530	10
MXFT12	MAXTREAM Commercial Filter 20" UF + Carbon Block Filter (Lead reduction)	6	385 X 265 X 530	10
MXFT13	MAXTREAM Commercial Filter 20" UF compound Filter (Scale inhibitor)	6	385 X 265 X 530	9
MXFT14	MAXTREAM Commercial Filter 20" UF compound Filter (Lead reduction & Scale inhibitor)	6	385 X 265 X 530	9
MXFT15	MAXTREAM Commercial Filter 20" R.O Membrane Filter (350GPD)	6	385 X 265 X 530	12
MXFT16	MAXTREAM Commercial Filter 15" Carbon filter (GAC)	6	385 X 265 X 400	9
MXFT17	MAXTREAM Commercial Filter 15" Carbon filter (GAC) (Scale inhibitor)	6	385 X 265 X 400	9
MXFT18	MAXTREAM Commercial Filter 15" Carbon Block Filter	6	385 X 265 X 400	8
MXFT19	MAXTREAM Commercial Filter 15" Carbon Block Filter (Lead reduction)	6	385 X 265 X 400	8
MXFT20	MAXTREAM Commercial Filter 15" Carbon Block Filter (Scale inhibitor)	6	385 X 265 X 400	8
MXFT21	MAXTREAM Commercial Filter 15" Carbon Block Filter (Lead reduction & Scale reduction)	6	385 X 265 X 400	8
MXFT22	MAXTREAM Commercial Filter 15" Carbon Block Filter (Cyst reduction)  (Listed No. PFC3215WCWT8)	6	385 X 265 X 400	8
MXFT23	MAXTREAM Commercial Filter 15" Carbon Block Filter (Lead reduction & Cyst reduction)	6	385 X 265 X 400	8
MXFT24	MAXTREAM Commercial Filter 15" Carbon Block Filter (Scale inhibitor & Cyst reduction)	6	385 X 265 X 400	8
MXFT25	MAXTREAM Commercial Filter 15" Carbon Block Filter (Lead reduction & Scale reduction & Cyst reduction)	6	385 X 265 X 400	8
MXFT26	MAXTREAM Commercial Filter 15" UF + Carbon Block Filter	6	385 X 265 X 400	7
MXFT27	MAXTREAM Commercial Filter 15" UF + Carbon Block Filter (Lead reduction)	6	385 X 265 X 400	7
MXFT28	MAXTREAM Commercial Filter 15" R.O Membrane Filter (250GPD)	6	385 X 265 X 400	9
MXFT29	MAXTREAM Commercial Filter 15" EFRO Membrane Filter (400GPD)	6	385 X 265 X 400	9

Maxtream Hybrid Filter System

Picogram New Technology
MaXtream hybrid



PPC-200

The hybrid water purification system with the excellent performance developed by the cutting edge technology in Korea. ESPRESSO / COFFEE / BEVERAGE / DRINKING WATER / ICE MAKER / STEAM / DISH WASHER



HC20

3 Filtration Steps in one filter
 High removal performance of Cyst, Residual Chlorine, VOCs, fine particle High flow rate



High Flow



Easy Filter Exchange



High Performance



No Power Required



Pure & Good Taste of Water



Certified KC Mark

Product Code	Description	Ports	Case Q'ty	Box Dimension (mm)	Weight (kg)
MXHHD01	Maxtream hybrid Head Connector 1 stage	3/8 inlet, 3/8 outlet	8	560 X 420 X 250	9
MXHHD02	Maxtream hybrid Head Connector 2 stage (series)	3/8 inlet, 3/8 outlet	4	560 X 420 X 250	9
MXHHD03	Maxtream hybrid Head Connector 2 stage (parallel)	3/8 inlet, 3/8 outlet	4	560 X 420 X 250	9
MXHFT01	Maxtream hybrid 15" Filter	Turn type	6	385 X 265 X 400	10
MAHC20	Maxtream 20" HC20 Filter	Turn type	6	385 X 265 X 530	12

Water Purifier Pitcher



- silver carbon, Ion exchange resin.
- Remove chlorine and heavy metals.



Portable



Economical



No Electricity

Product Code	Description	Size (mm)	Case Q'ty	Filter Size (mm)	Weight (kg)
PPP-100	Pureal Pitcher Water Purifier	(W)250 x (D)170 x (H)270	1	100 X 57 X 78	1.5
Filter	Pureal Pitcher Water Purifier Filter	(W)100 x (D)57 x (H)78	3		0.4

Vitamin Shower Filter



FDA Approved Sediment Filter



Residual Chlorine Removal



Vitamin-C



- For Adult
Vitamin C, Arbutin, Milk Powder, Saururus Chinensis Extract
- For Baby
Vitamin C, Olive Oil
- ZERO
Sediment Filter, Anti-Bacterial Ball

State of the art Ro Membrane Technology

Eco Friendly Reverse Osmosis Element

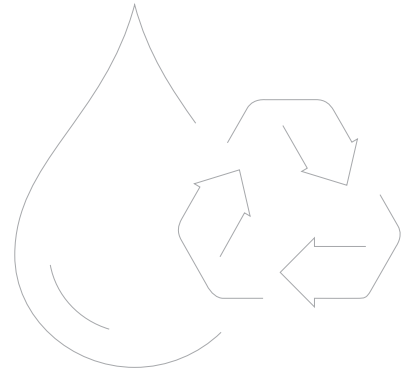

Longer Pre-filter life time

Less waste water

Compact system

More product water

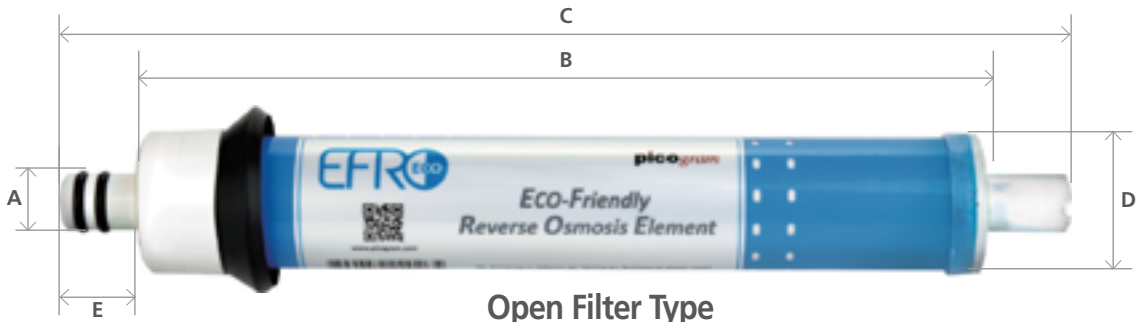

Dimensions & Specifications

*NSF Listed No. EFN-ZZXX-YYY

Model Name	A (inch)	B (inch)	C (inch)	D (inch)	E (inch)	Permeate Flow Rate Salt Rejection GPD (L/day)	Salt Rejection (%)
EFN-1512-50	0.67	9.61	11.73	1.63	0.87	50(189)	96
EFN-1612-75	0.67	8.54	11.73	1.89	0.87	75(284)	96
EFN-1812-100	0.67	9.61	11.73	1.89	0.87	100(379)	96

* The stated product performance is based on data taken after 30 minutes of operation at 50% of recovery

* The following flow restrictors are recommended; EFN-1512-50(150ml/min), EFN-1612-75(200ml/min), EFN-1812-100(250ml/min)

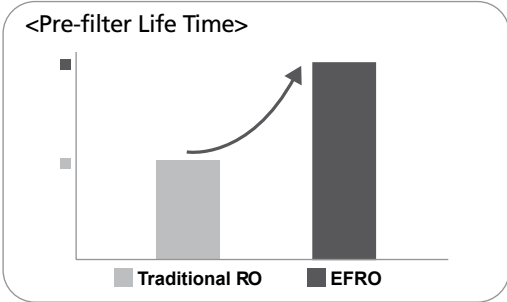

As EFRO requires less feed water, it increases the Life time of Pre-filters

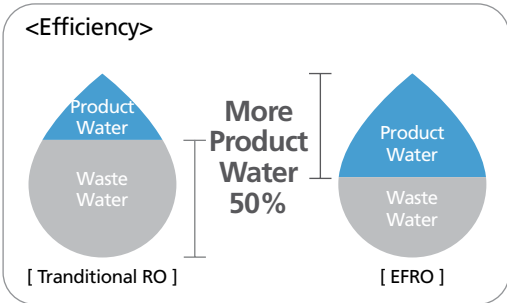

The traditional R/O Membrane wastes 75% of water

Optimized RO module structure of EFRO allows brine water to flow faster inside, which provides various and effective advantages to RO membrane performance and helps improve the efficiency of water purifiers. In addition, as this EFRO has the same flow structure as the traditional RO membrane modules, it can also replace current RO system without any trouble.

- Reduces the ratio of waste water to 50% of feed water
- Prevents the clogging problems of the RO Filters
- Improves the life time of the RO membrane
- Increases the life time of Pre-filters (EFRO requires less feed water)
- Helps to develop RO system with more compact size
- Capable to replace Traditional RO module with EFRO (Flow restrictor change required) Eco-Friendly RO Membrane that contributes to a sustainable environment through reducing water consumption



Inline Filter Type

Model Name	A (inch)	B (inch)	Permeate Flow Rate GPD (L/day)	Salt Rejection (%)
EFI-1512-50	2.6	11.1	50 (189)	96
EFI-1612-75	2.6	11.1	75 (284)	96
EFI-1812-100	2.6	11.1	100 (379)	96

* The stated product performance is based on data taken after 30minutes of operation at 50% of recovery

* The following flow restrictors are recommended; EF-50G(150ml/min), EF-75G(200ml/min), EF-100G(250ml/min)



New Technology PHC CARBON BLOCK

Picogram Heat-Compressed Carbon Block



- Jig heating carbon production system
- Any size are available (OEM size)
- Any materials are available (OEM materials / Jacobi, Kuraray, Haycarb)
- High production capacity
- High chemical adsorption performance
- Nominal 5 micron pore size
- Safety and certified materials using
- Apply to all Picogram standard filters
- Reasonable price by Automatic production system





Functional Filter Material

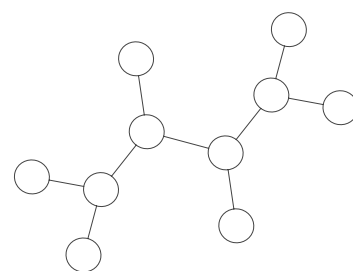
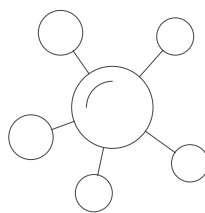

* When door open it shuts off the feed water and release the internal pressure.

Picture	Product Code	Item	Feature
	7205700(Φ10) 7205701(Φ7.5) 7205702(Φ5)	SA Ball (Super Antibacterial Ball)	· Antibacterial process of water · Applicable in storage tank (w/cartridge)
	7200105(Φ3)	Antibacterial Ceramic Ball	· Antibacterial process of water · Applicable in storage tank (w/cartridge)
	Strong Type 7200305(Φ3) 7202100(Φ7)	pH Control Ceramic Ball	· Alkalization of water · Mineral elution (Ca)
	Normal Type 7200306(Φ3) 7202101(Φ7)		
	7200307(Φ5)	Mg Ball	· Alkalization of water · Mineral elution (Mg)
	7205800OSA(Φ3) 7205801OSA(Φ3)	ACT (Alkaline Ceramic T-Bag)	· Change ORP in the water · Remove Free Radical (by generate Hydrogen molecule & atom) * Sufficient consultation is required when applying
	7202500(Φ3) 7200201(Φ5)	pico π ball (Far-Infrared ray ceramic ball)	· Far-infrared ray release · Activation of water
	7200500(Φ5) 7200501(Φ10)	Tourmaline Ceramic Ball	· Electric characteristics of low electric current · Anion generated · Electrolysis of water molecules with temporary discharge
	7200400(5mm)	Coral Sand	· Various mineral elution (Na, Ca) · Better taste of water
	7202800(Φ2~7)	Polyphosphate	· Inhibit scale formation
	7202000	KDF55	· Remove Chlorine and Heavy Metal